

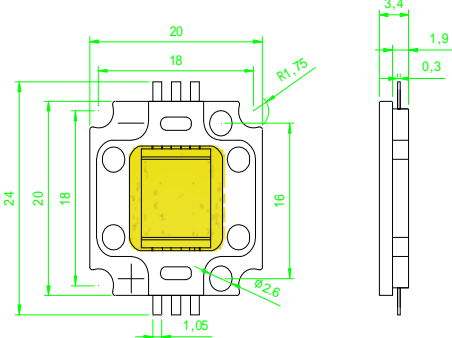

**DRD Series COB (Chip on Board) High Power LED emitters**

**10W COB**

Part No.	VF(V)	Luminous flux (Lm)			CCT(K)	CRI(Ra)		
		Min.	Typ.	Max.		Min.	Typ.	Max.
DRD-010WM1A4-XX	30-36	~	1000	~	2600-10000	~	70	~







**20W COB**

Part No.	VF(V)	Luminous flux (Lm)			CCT(K)	CRI(Ra)		
		Min.	Typ.	Max.		Min.	Typ.	Max.
DRD-020WM5A4-XX	30-36	~	2000	~	2600-10000	~	70	~



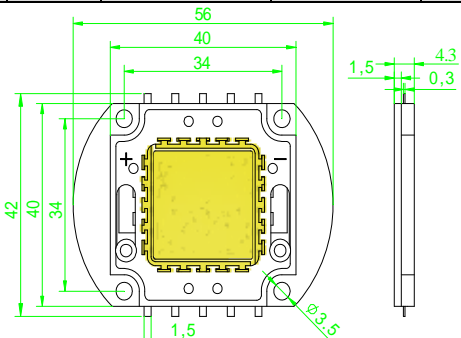

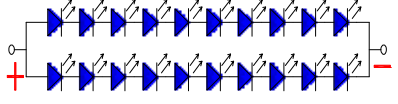

**30W COB**

Part No.	VF(V)	Luminous flux (Lm)			CCT(K)	CRI(Ra)		
		Min.	Typ.	Max.		Min.	Typ.	Max.
DRD-030WM5A4-XX	30-36	~	3000	~	2600-10000	~	70	~



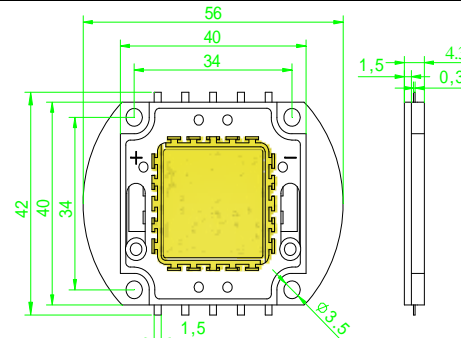

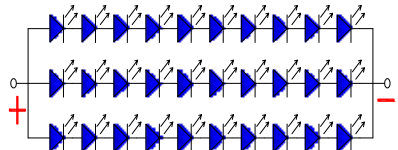

**DRD Series COB (Chip on Board) High Power LED emitters**

**50W COB**

Part No.	VF(V)	Luminous flux (Lm)			CCT(K)	CRI (Ra)		
		Min.	Typ.	Max.		Min.	Typ.	Max.
DRD-050WM5A4-XX	30-36	~	5000	~	2600-10000	~	70	~





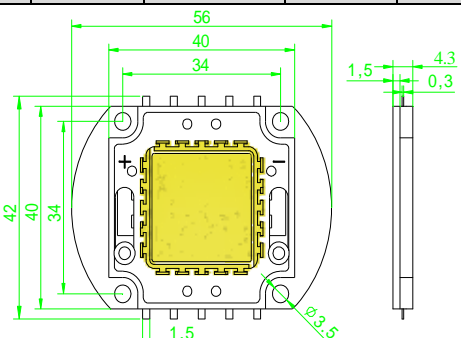

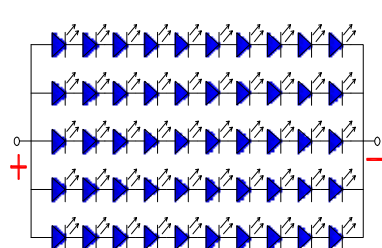
**80W COB**

Part No.	VF(V)	Luminous flux (Lm)			CCT(K)	CRI(Ra)		
		Min.	Typ.	Max.		Min.	Typ.	Max.
DRD-080WM5A4-XX	30-36	~	8000	~	2600-10000	~	70	~



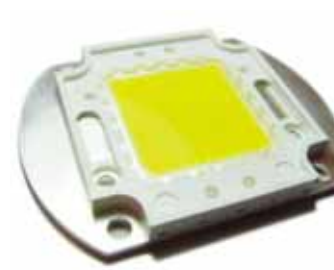

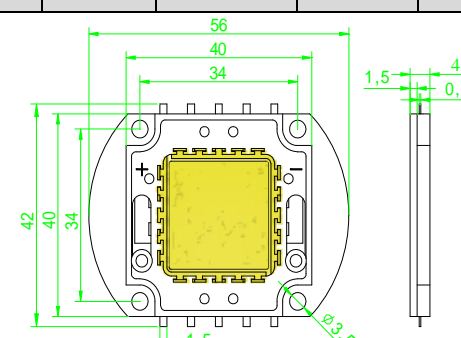

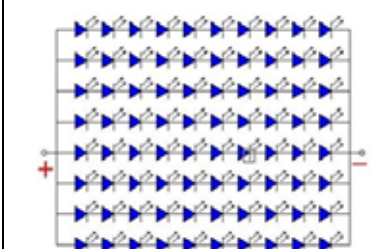
**150W COB**

Part No.	VF(V)	Luminous flux (Lm)			CCT(K)	CRI(Ra)		
		Min.	Typ.	Max.		Min.	Typ.	Max.
DRD-150WM9A4-XX	45-50	~	15000	~	2600-10000	~	70	~





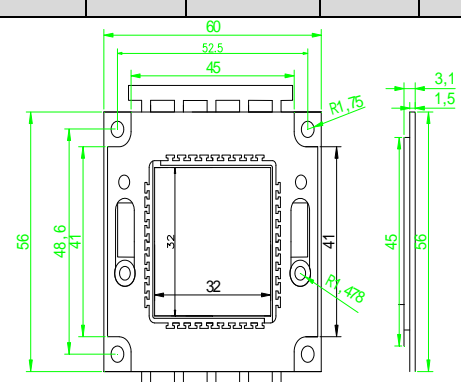

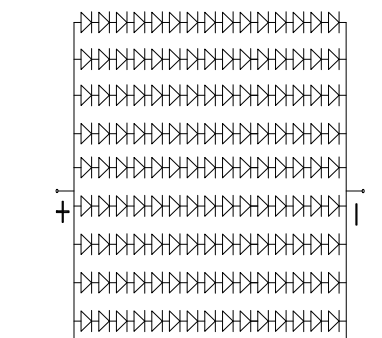
**DRD Series COB (Chip on Board) High Power LED emitters**

**200W COB**

Part No.	VF(V)	Luminous flux (Lm)			CCT(K)	CRI(Ra)		
		Min.	Typ.	Max.		Min.	Typ.	Max.
DRD-200WM9A4-XX	30-36	~	20000	~	2600-10000	~	70	~

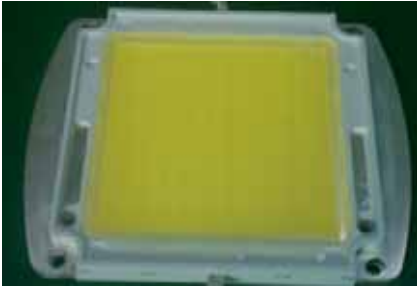
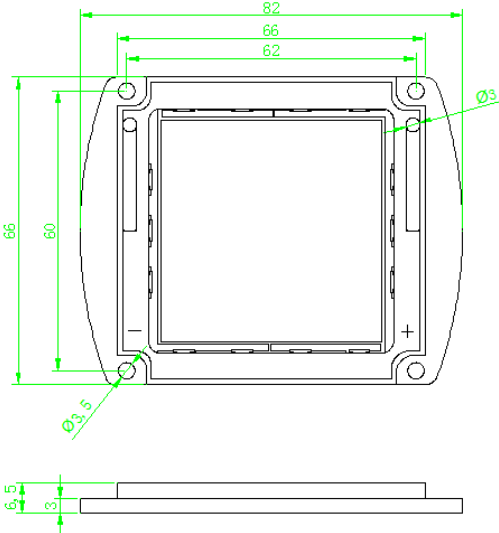
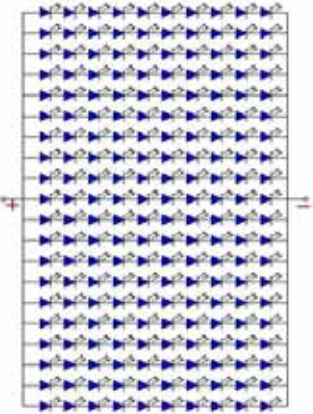
		
---	---	---